User's Guide

PSC805 Aurilium™ 5.1 External Audio Processor Plus PSA2™



Philips Sound Solutions
May 2003



PHILIPS

Software End User License Agreement

ATTENTION: THIS SOFTWARE IS SUBJECT TO THE LICENSE TERMS DESCRIBED BELOW. USE OF THIS SOFTWARE INDICATES ACCEPTANCE OF THE LICENSE TERMS. IF YOU DO NOT ACCEPT THESE LICENSE TERMS, YOU MAY RETURN THE SOFTWARE FOR A FULL REFUND. IF THE SOFTWARE IS PACKAGED WITH ANOTHER PRODUCT, YOU MAY RETURN THE ENTIRE UNUSED PRODUCT FOR A FULL REFUND.

© KONINKLIJKE PHILIPS ELECTRONICS N.V. 2002 All rights reserved. Reproduction in whole or in part is prohibited without the written consent of the copyright owner. This software has been made available for use by end users only.

1. **Copyright**

The Licensed Software is a proprietary product of Philips, and is protected by copyright laws. Title, ownership rights and intellectual property rights in and to the Licensed Software shall remain with Philips.

2. **Right to use**

Philips hereby grants you the personal, non-exclusive license to use the Licensed Software only on and in conjunction with one (1) computer at one time. You may not sell, rent, redistribute, sublicense or lease the Licensed Software, or otherwise transfer or assign the right to use it. You may not decompile, disassemble, reverse engineer, or in any way modify program code, except where this restriction is expressly prohibited by applicable law. Except for one (1) copy which may be made for backup purposes only, you may not copy the Licensed Software. You are not allowed to alter or remove any proprietary notices, including copyright notices, in the Licensed Software.

3. **Disclaimer of Warranty**

THE LICENSED SOFTWARE IS PROVIDED AS IS WITHOUT WARRANTY OF ANY KIND. THE ENTIRE RISK OF USE OF THE LICENSED SOFTWARE REMAINS WITH YOU. TO THE MAXIMUM EXTENT PERMITTED BY LAW, PHILIPS MAKES NO FURTHER REPRESENTATIONS OR WARRANTIES EXPRESSLY OR IMPLIED SUCH AS BY WAY OF EXAMPLE BUT NOT OF LIMITATION REGARDING MERCHANTABILITY OR FITNESS FOR ANY PARTICULAR PURPOSE, OR THAT LICENSED SOFTWARE IS ERROR FREE, OR THAT THE USE OF THE LICENSED SOFTWARE OR ANY COPIES THEREOF WILL NOT INFRINGE ANY PATENT, COPYRIGHT, TRADEMARK OR OTHER RIGHT OF THIRD PARTIES.

4. **Updated**

This license does not grant you the right to any upgrades or updates of the Licensed Software. However, Philips will be entitled to offer updates and/or modifications to the Licensed Software at its discretion.

5. **Changes of the agreement**

No changes of this Agreement are valid unless with Philips' and your written approval. Any terms and conditions provided by you are inapplicable, whether or not contained in order forms or otherwise, unless specifically accepted by Philips in writing by means of a duly signed addition to this Agreement.

6. **Limitations of liability**

PHILIPS ACCEPTS NO LIABILITY FOR ANY DAMAGES, INCLUDING ANY LOSS OF PROFIT, LOSS SAVINGS, LOSS OF DATA, BUSINESS INTERRUPTIONS, OR ANY DIRECT, INDIRECT, INCIDENTAL, CONSEQUENTIAL, SPECIAL OR PUNITIVE DAMAGES ARISING OUT OF YOUR USE OR INABILITY TO USE THE LICENSED SOFTWARE, EVEN IF PHILIPS OR ITS REPRESENTATIVES HAVE BEEN ADVISED OF THE POSSIBILITY OF SUCH DAMAGES, OR FOR ANY CLAIM BY ANY OTHER PARTY. SINCE SOME JURISDICTIONS DO NOT ALLOW THIS LIMITATION OF LIABILITY, THIS LIMITATION OF LIABILITY MAY NOT APPLY TO YOU.

7. **Validity and Termination**

The license granted hereunder shall terminate automatically and without notice if you do not comply with all the terms and conditions of this End User License Agreement. In the event of termination, you shall immediately stop any use of the Licensed Software and destroy all copies thereof. In addition, in the event of termination because of your failure to comply with your obligations, Philips reserves the right to invoke any and all other remedies available to it in law or contract including the right to claim damages.

8. **Applicable Law**

This contract shall exclusively be governed by the laws of the Kingdom of The Netherlands without regard to its conflict of law provisions.

9. **Competent Court**

The competent court for any dispute between you and Philips pursuant to this End User License Agreement is the court of 's-Hertogenbosch, the Netherlands.

© Philips Consumer Electronics B.V., 1999-2002, Eindhoven, The Netherlands

V-1 991214

What Is Included In the Package

You will find the following items in the package:

- The Aurilium Sound Processor
- Foot stand for vertical or horizontal mounting
- Fastening screw
- Standard USB cable
- The Aurilium installation CD
- The Aurilium User's Guide (on the installation CD)
- Quick Start Guide (QSG)
- Audio Software applications (on the installation CD)
- Warranty card

Philips Aurilium™

5.1 Channel External USB Sound Processor

© Copyright 2002

Aurilium™ is a trademark of Philips Sound Solutions.

Philips Sound Agent 2™ and PSA2™ are trademarks of Philips Sound Solutions.

QSound™, QEM™, QSound Environment Modeling, QSound Multi-Speaker Systems, QMSS™, QMSS™, Q3D™, QSurround™, QXpander™, QInteractive3D™, Audio Pix™, and the Q logo are trademarks of QSound Labs, Inc.

EAX™ and Environmental Audio Extensions are trademarks of Creative Technology Ltd. In the United States and other countries.

Microsoft™ and Windows™ are registered trademarks of Microsoft Corporation.

DirectX™ and DirectSound™ are trademarks of Microsoft Corporation.

All other trademarks are the property of their respective owners.

Table Of Contents

1. Introduction.....	1
1.1. <i>KEY FEATURES</i>	2
1.2. <i>Minimum System Requirements</i>	3
2. The Philips Aurilium Hardware	4
2.1. <i>Getting Started</i>	4
2.1.1. Front Panel Features and Controls	5
2.1.2. Rear Panel Connectors.....	7
2.2. <i>Quick Installation Guide</i>	9
2.3. <i>Detailed Installation Guide</i>	10
2.3.1. Hardware Installation	10
2.3.2. Speaker Connection	10
2.3.3. USB Connection	11
2.3.4. Software Installation.....	13
3. Using the Hardware Controls.....	15
4. The Philips Sound Agent 2 (PSA2).....	17
4.1. <i>Basic Interface Operation</i>	17
4.2. <i>Compact Control Panel</i>	19
4.3. <i>Main Control Panel</i>	21
4.3.1. Effects Tab.....	21
4.3.2. Equalizer Tab.....	23
4.3.3. Setup Tab	24
4.3.3.1. Invalid Speaker Configuration	24
4.3.4. Mixer Tab.....	27
4.3.4.1. Playback source controls	27
4.3.4.2. Recording Source Control	28
4.3.5. Presets Tab	28
4.3.6. Info Tab	30
4.4. <i>Visualization Panel</i>	31
5. Uninstalling PSA2.....	32
6. Technical Support And Warranty	34

- 6.1. *Internet Address:*34
- 6.2. *Technical Support Information:*.....34
- 7. Appendix A, Useful Tips For Speaker setup..... 35**
 - 7.1.1. Ideal Listening Scenario (Speakers).....35
 - 7.1.2. Ideal Listening Scenario (Headphones)35
 - 7.1.3. Avoid Reflective Surfaces (Speakers)35
 - 7.1.4. Balance the Speakers and Headphones35
- 8. Appendix B, USB Hub Considerations..... 36**
 - 8.1. *Introduction to USB Hub*.....36
 - 8.1.1. Power Limitation36
 - 8.1.2. Bandwidth Limitation Issues.....36
- 9. Appendix C, Trouble Shooting 37**

1. Introduction

Thank you for purchasing the PSC 805, **Aurilium 5.1 USB Sound Processor!** You now own the ultimate in quality and flexibility for your PC sound.

Your new external sound processor offers all the advanced features of any internal sound card, plus the convenience of not having to take off the cover of your PC.

1.1. KEY FEATURES

Gaming and Music-centric audio components transform your laptop or desktop computer into an advanced digital audio processor!

- Easy USB connection. No need to open your PC case (ideal for laptops).
- USB bus powered. No external power required.
- 24-bit high definition data converters for optimum sound quality.
- Sound Agent 2 interactive visual sound control center.
- All main audio functions can be controlled internally via Sound Agent 2 or front panel external controls.
- Automatically detects the number of speakers plugged in and optimizes output for the best sound possible.
- Detects the presence of headphones and automatically mutes speakers when the headphone jack is inserted, and un-mutes when jack is unplugged.
- Detects the presence of microphones and automatically switches the input from Line-In to Mic-In when microphone jack is inserted, and switches input back to Line-In when jack is unplugged.
- Cool blue indicator LED's clearly show selected functions and levels.
- Easy desktop connection for microphone, headphones, and speakers.
- **QInteractive3D** technology offers precise 3D sound positioning with all headphone and speaker output configurations and is compatible with DirectSound3D, EAX 1.0, EAX 2.0/I3D Level 2, and A3D enabled games.
- **QXpander** converts ANY ordinary stereo input to virtual 3D surround sound with any headphone or two-speaker set configuration.
- 15 unique reverb environments using the exclusive **QSound Environmental Modeling (QEM)** algorithms for totally immersive gaming and dramatic musical performances.
- Active Dynamic Filtering found in the new **QSizzle** and **QRumble** components feature low, mid and high frequency enrichment algorithms that help restore sonic fidelity for highly compressed digital audio files such as MP3s and WMAs. Simply put, it makes MP3's sound great.
- Exclusive **QMSS5.1** technology creates 6 independent channels of audio from ALL stereo sources when in 5.1 channel speaker mode.
- **QSurround** enhances Dolby Digital 6-channel sources by filling the sound gap between speakers to create a complete 360-degree wrap-around audio experience that is smooth and natural. But more importantly, it creates virtual 3D surround over a two-speaker setup.
- **Normalization** smoothes out the volume differences within audio files and reduces the volume variations for all audio sources - automatically.
- Professional style **10-Band Equalizer** for precise sound tailoring of all digital audio media.
- Industry standard digital output (S/PDIF Out) allows connection to digital speakers or external decoders.
- Two ways to connect to your S/PDIF Digital Out: Optical or Coax connectors.
- **Default** and user defined **Preset**s for most settings to personalize all your games, music, and movies - exactly the way you like it.

1.2. Minimum System Requirements

350 MHz CPU
64 MB RAM
One CD ROM drive
One available USB port
800 X 600 Screen resolution (1024 X 768 recommended)
Headphones or amplified speakers
20 MB of available hard drive space
Windows® 2000 or Windows® XP operating system.

Please Note: *Each operating system has its own minimum requirements which should be observed. In addition, various games and DVD applications may require higher limits than listed above.*

2. The Philips Aurilium Hardware

2.1. Getting Started

To fully benefit from all the features of your Aurilium Sound Processor, please take a moment and familiarize yourself with this guide in its entirety. The diagrams in the next two pages list all the features available.

The **installation Video** on the installation CD can provide you with a quick overview of how to install your new Sound Processor. Additional installation Information is contained in this manual.

Note: Not installing PSA2 will limit the Aurilium sound processor to stereo output only.

2.1.1. Front Panel Features and Controls

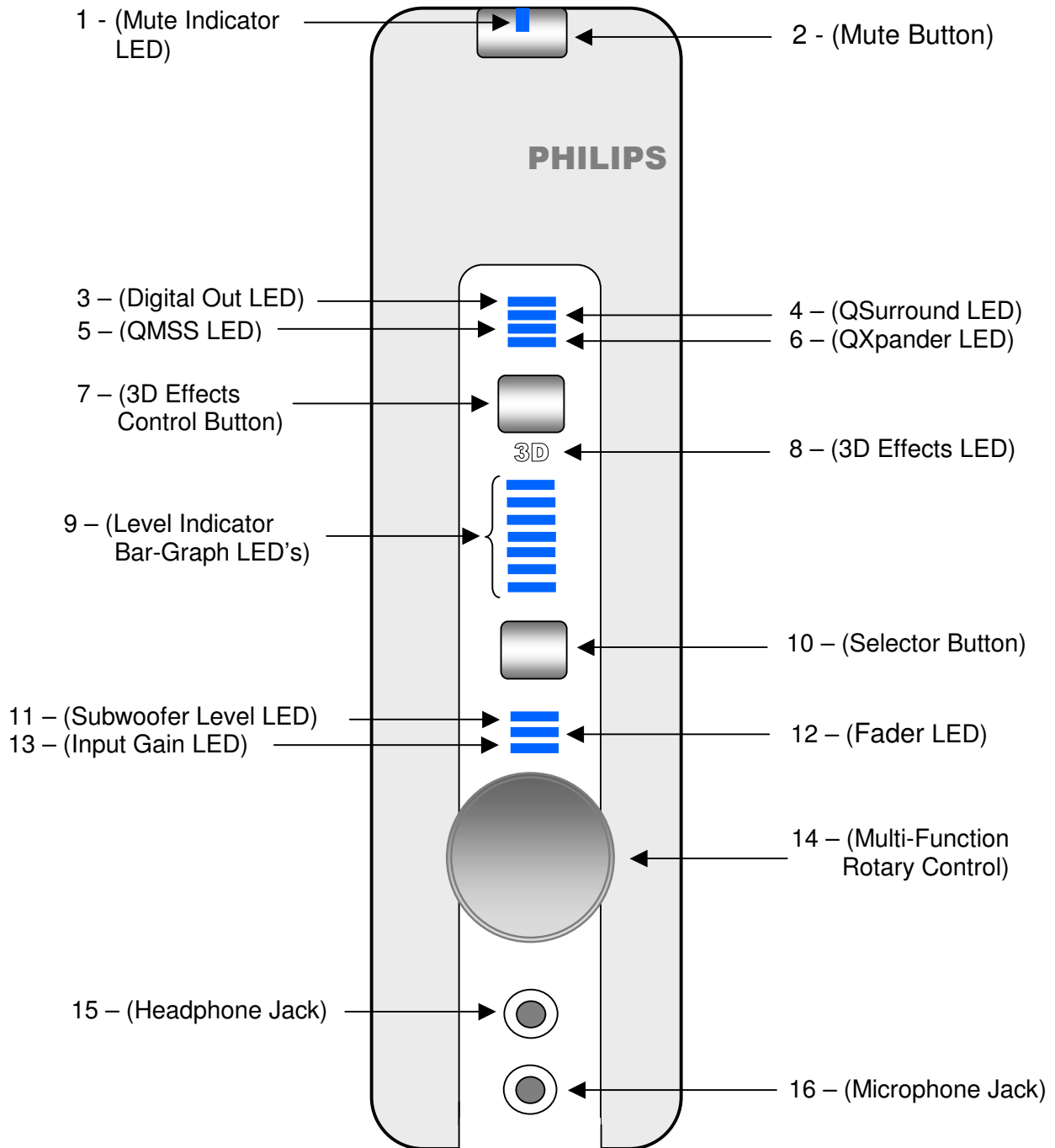

Figure 1. Front view Features

See next page for brief description of features

The following is a brief description of all controls and indicators located in the front of the Aurilium Sound Processor. For an in-depth explanation of each control or indicator refer to the ***Using the Hardware Controls*** chapter of this document.

1. Mute Indicator LED: Indicates when Mute function is active.
2. Mute Button: Toggles all audio output on or off.
3. Digital Out Indicator LED: Indicates S/PDIF Out is enabled/disabled.
4. QSurround Indicator LED: Indicates QSurround is active.
5. QMSS Indicator LED: Indicates QMSS is active.
6. QXpander Indicator LED: Indicates QXpander is active.
7. 3D Effects Control Button: Toggles the 3D Effects on or off.
8. 3D Effects Indicator LED: Indicates that 3D Effects mode is active.
9. Level Indicator Bar Graph LED's: This set of seven LED's indicate the level of volume, or the level of the Fader, Subwoofer, or Input Gain depending on which function has been selected by the Selector Button (No. 10). When all three function LED's are off, the bar graph indicates the volume level.
10. Selector Button: By pushing this button you can select which function is controlled by the Rotary Control Knob (No. 14) as indicated by the function LED's (No. 11,12, and 13). The level of each function is displayed by the Level Indicator bar-graph LED's (No. 9).
11. Subwoofer Level LED: When lit, the rotary knob controls the subwoofer level as indicated by the level indicator bar graph LED's (No. 9).
12. Fader Indicator LED: When lit, the rotary knob controls the level of fader as indicated by the level indicator bar graph LED's (No. 9).
13. Input Gain Indicator LED: When lit, the rotary knob controls the level of input gain as indicated by the level indicator bar graph LED's (No.9).
14. Multi-Function Rotary Control: This knob controls the level of the volume, fader, subwoofer or input gain as indicated by the function LED's (No. 11, 12, and 13).
15. Headphone Jack: Attach headphones here.
16. Microphone Jack: Attach microphone here.

2.1.2. Rear Panel Connectors

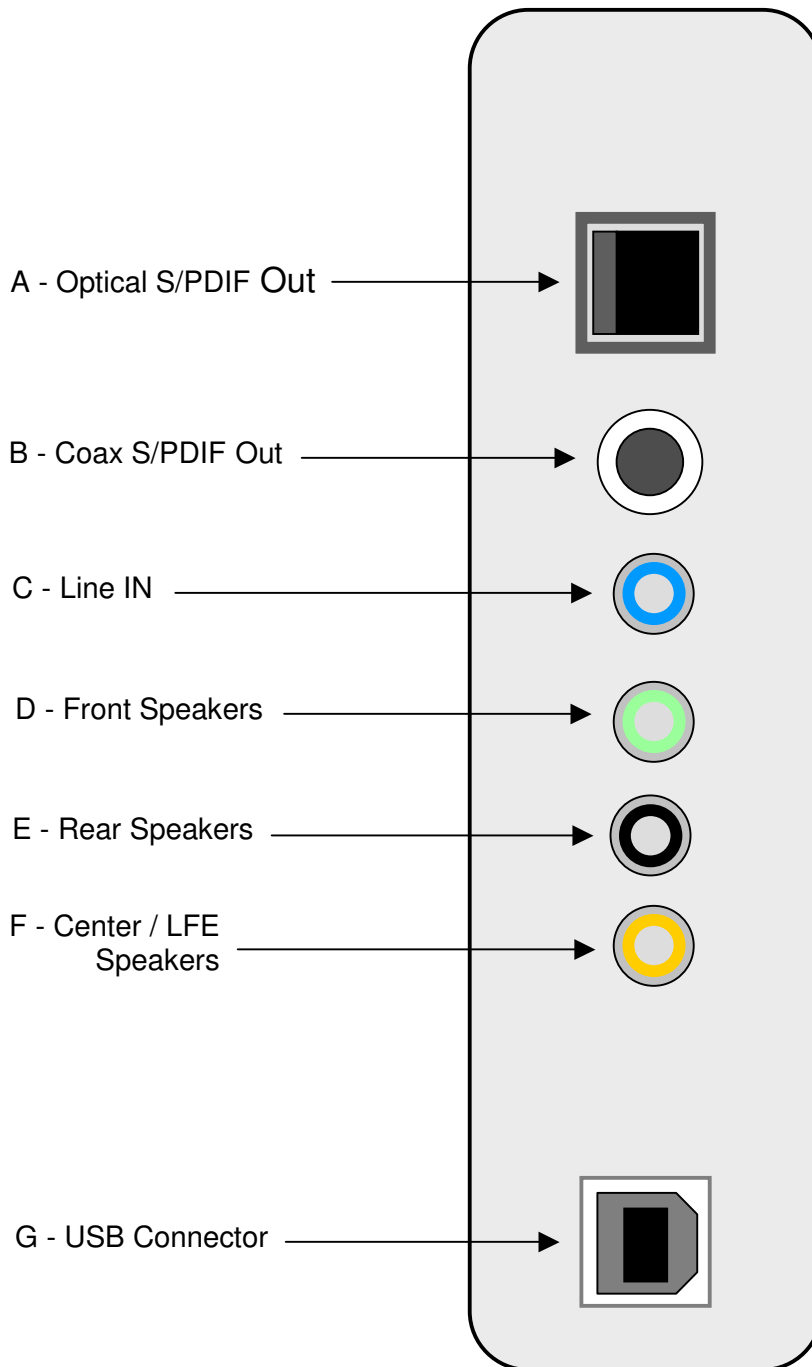

Figure 2 Back Panel

See next page for brief description of features

This is a brief description of all the audio connectors located on the back panel of the Aurilium sound processor. For an in-depth explanation of each audio connector, please refer to the ***Using the Hardware Controls*** section of this document.

- A. Optical output jack for digital (S/PDIF) signal out
- B. Coax (RCA) output jack for digital (S/PDIF) signal out
- C. Line IN, standard stereo two-line jack (blue)
- D. Front speakers, standard stereo jack (lime green)
- E. Rear speakers, standard stereo jack (black)
- F. Center/LFE, standard stereo jack (orange)
- G. Standard B-type USB connector

2.2. Quick Installation Guide

Installing the Aurilium is very simple and can be done in three easy steps. However, if you need more information, please refer to the **Detailed Installation Guide** section following this section.

Step 1:

Attach the base to the desired location as shown in **Figure 3**, depending on how you wish to position the unit. Fasten the base to the Aurilium case with the included screw. Do not over tighten as this may cause damage to the case.

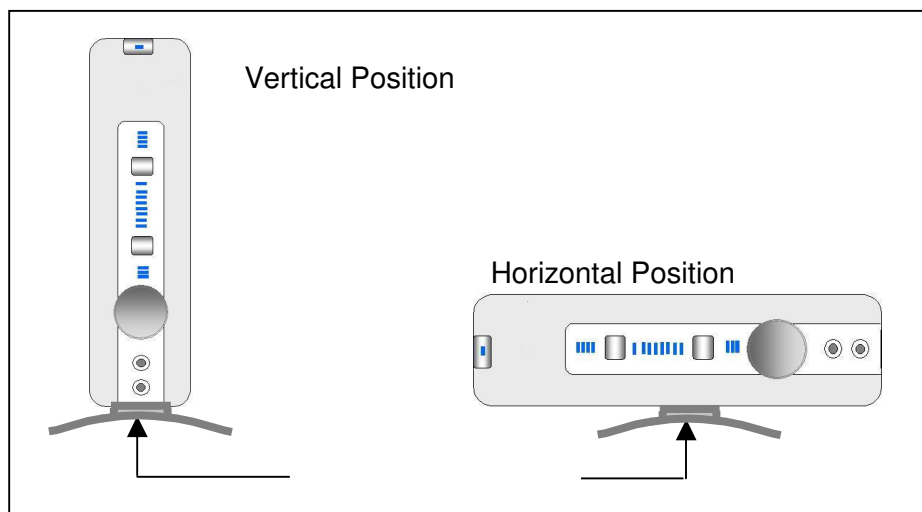

Figure 3

Step 2:

Connect the USB cable (included) to the USB connector on the back of the Aurilium, and then attach the other end to the USB port of the PC. The USB port may be in the back or front of the PC as most new computers have USB ports in either location. Refer to the documentation of your computer to locate the USB port. Connect self-powered speakers to the audio jacks located on the back of the Aurilium. If you have more than two speakers, make sure you connect the correct speakers to the appropriate jacks.

You may have to use a USB hub if all the USB ports of your PC are being used. If you are not familiar with USB hubs, please refer to Appendix B, **USB Hub Considerations** of this users guide.

Step 3:

Install the Philips Sound Agent 2 using the installation CD (included). Place the CD in the CD drive and let Autorun launch the PSA2 Autolauncher installation panel. Click on the "Install Philips Sound Agent 2" button and follow the instructions on the screen.

If Autorun is disabled, go to the Start menu at the bottom of your screen and click on Run. Type the following in the Run window and click OK:

D:\autolauncher.exe (where D:\ is your CD drive designator letter).

Note: Not installing PSA2 will limit the Aurilium sound processor to stereo output only and its advanced features will be inoperative.

2.3. Detailed Installation Guide

Your new Aurilium sound processor is a standard USB audio device. This means even if you don't install PSA2, you will still be able to play all your PC audio streams just by connecting the Aurilium Sound Processor to the USB port on your PC. This, however, will not give provide full functionality. Be sure to install the Philips Sound Agent 2 drivers to enjoy the full benefits of your state of the art PC sound device. First, install the hardware as follows:

2.3.1. Hardware Installation

Before you install the hardware, you need to assemble the base to the box. You can position the Aurilium box horizontally or vertically on your desk. Attach the base to the narrow, or the wide side of the box as shown in **Figure 3**. Use the accompanying screw to secure the base to the Aurilium case. **Over tightening may damage the case.**

2.3.2. Speaker Connection

You need to have a set of self-powered speakers. Self-powered means they have their own power supply that plugs into an AC outlet or uses batteries. It is strongly recommended that you refer to the documentation that came with your speakers to determine the type and connection for your speakers. If you have commonly used set of PC stereo speakers, connect them to the green jack labeled "Front" in the back of Aurilium (see **Figure 2**).

Important Note: If you connect the Rear speakers or the subwoofer before connecting the front speakers, an "Invalid Speaker Configuration" error message will appear at the lower right hand corner of the screen as shown in **Figure 4**. When you only have two speakers, even if they are positioned behind you, they must be connected to the front jack. See "**Invalid Speaker Configuration**" section under Setup tap description section in this document.



Figure 4 Invalid Speaker Configuration error message

If you have digital speakers, or any type of digital decoder box that uses a digital audio (S/PDIF) signal, identify the type of cable that is supplied with the speaker set. The Aurilium Sound Processor has two types of digital signal output connectors, the RCA jack and the optical connector. Connect the cable to the appropriate jack on the back of the Aurilium. The optical connector may have a protective cap that needs to be removed before connecting to it. To enable Digital output go to the Setup Tab of the PSA2 panel (see Setup Tab description under **Main Control Panel** section of this document).

Check out www.philips.com/sound (Europe) or www.philips.com/ce (US) to see Philips' full range of self-powered speakers.

2.3.3. USB Connection

The included USB cable has different connectors on each end. Connect the appropriate end to its respective port. A USB port on a PC may be located in the front, in the back, or both. On laptops, it may be on the back alongside other ports and connectors, or on either side of the PC.

Personal computers normally have at least two USB ports. Most new PC's have two in the back and two in the front. The front USB ports may be concealed under a flip-up cover. You should refer to your PC documentation to locate the USB port. **Figure 4** shows examples of USB ports on laptop and desktop PC's.



a. Diagram of USB ports in the back of PC



b. Pictures of USB ports in front of PC

Figure 5 Typical Locations for USB Ports

The Aurilium is compatible with both USB 1.1 and USB 2.0. If your PC has both, you can connect to either port. Windows 2000 and Windows XP recognize the Aurilium Sound Processor as an audio device and assign the required basic drivers to the hardware. Once the Aurilium is recognized and installed, you should be able to play MP3 and other audio streams, including your music CD's. However, you must install PSA2 to enable all the unique features of your new sound processor. If you do not install PSA2, you will only have stereo output.

Both Windows 2000 and XP automatically detect Aurilium without any input from the user. If you are familiar with the USB device installation process by Windows, go to the **Software Installation** section of this document.

Windows XP:

When you first connect the Aurilium (or any USB device), Windows detects the connection and displays the message “Found new hardware” at the lower right corner of your screen (see **Figure 5**). The message may be followed by another message “USB Audio Device”, or “PSC805 Audio Device”. The detection process may take up to a few minutes depending on the speed of your computer. When the process is finished, it displays the message: “Your new hardware is installed and ready to use”. See **Figure 5**. You are now ready to install your PSA2 software that is provided on the installation CD.



Figure 6

Windows 2000

When installing the Aurilium on a system with Windows 2000, the “Found New Hardware” window opens and stays open throughout the process of hardware installation. You will see the text change back and forth (see **Figure 6**), but when the window goes away it means the Aurilium has been installed.

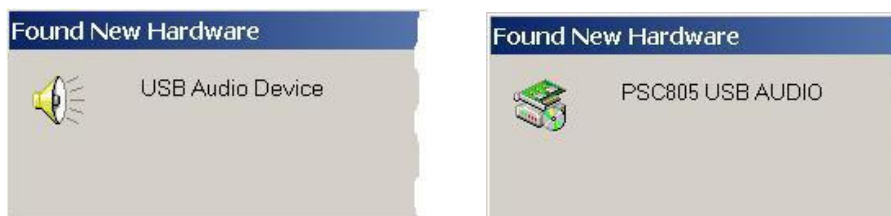

Figure 7

2.3.4. Software Installation

Place the installation CD into the CD-ROM drive. The PC will detect the CD and automatically bring up the application launch panel (see **Figure 7**). Click on the “Install Philips Sound Agent 2” button and follow the directions on the screen.

If for any reason the application launch panel is not launched, click on the Start button and select Run. In the window type the following:

D:\autolauncher.exe

Where D:\ is the letter designator for your CD ROM drive.

Click OK.

Once the installation is complete, you will be asked to restart your computer. After the reboot, the Philips Sound Agent 2 icon will appear in your Windows System Tray (or Systray, normally at the lower right hand corner of screen), as shown in **Figure 9**.

If you want to install any or all of the included free applications, reinsert the CD or follow the above direction to bring up the Autolauncher panel again.

When installation is complete, it is a good idea to run the speaker test utility (under the Setup tab of PSA2 main control panel) to ensure proper connection.

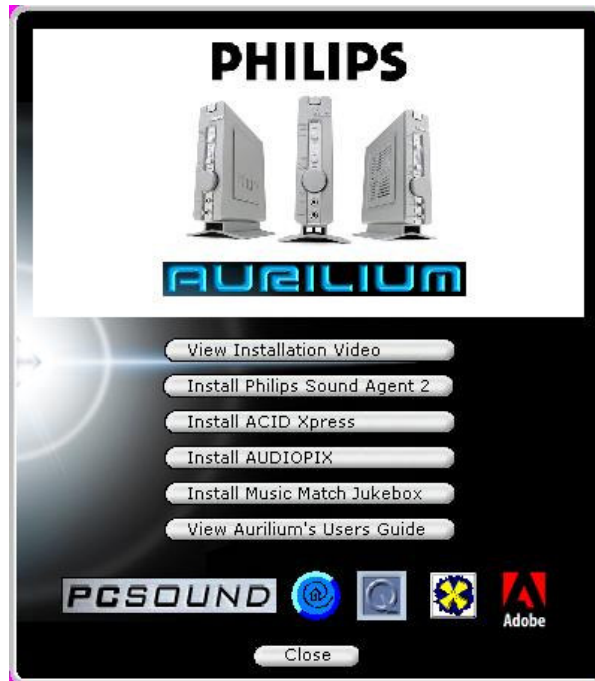

Figure 8



Figure 9 System Tray

3. Using the Hardware Controls

The Aurilium Sound Processor has a number of controls on the front panel that enable various audio features. The Aurilium automatically detects how many speakers are connected. It also detects if headphones are connected to the headphone jack, and automatically mutes all the speakers. Microphone and Line In connections are also automatically detected.

Following is a detailed explanation of the controls and indicators.

Mute Button and Mute LED

Pushing this button disables the sound to all speakers, but does not stop the player application that is sending audio to the Aurilium. Push the button again to enable audio out. This button functions the same as the mute button on the PSA2 panel. When LED is on, mute is active.

Top Four LED's

The first of the top four LED's is the Digital Out indicator. When lit, it indicates that encoded audio (AC3 or DTS) is enabled through both the RCA and optical outputs. See AC3/DTS Pass Through under Setup Tab.

The second LED indicates that QSurrround is active. This feature automatically becomes active when a source signal (usually DVD) is configured to be 6-channel out and only two speakers are connected to the Aurilium. This feature gives you a virtual 3D surround sound. If more than two speakers are connected to the Aurilium, then this feature enhances the surround sound to provide a virtual full surround sound.

The third LED, when lit, indicates QMSS is active. When you have a stereo source and have attached four or more speakers to the Aurilium this feature automatically comes on and converts the stereo source to multi-channel surround sound.

The fourth LED, when lit, indicates QXpander is on. This feature automatically comes on when you have a stereo source (MP3 or CD audio) and two speakers or headphones are connected to the Aurilium.

3D Effects Control Button

This button enables 3D Effects. The characters "3D" below the button illuminate when any of the 3D Effects are active. See 3D Effects in PSA2 section of this user guide for more information.

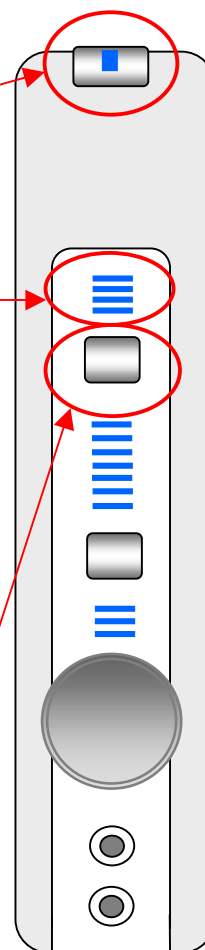

Level Indicator Bar Graph LED's

This set of seven LED's display the level of the volume as a bar graph. They also display the level for Fader, subwoofer, and microphone input gain, depending on which function is selected by the Selector button. You can change the level of the selected function using the Multi-Function Rotary Control.

Selector Button And LED's

By pushing the Selector button you change the function of the Rotary Control knob and the display contents of the Level Indicator LED's.

By default, all three Function LED's are off, the Multi-Function Rotary knob controls the volume level, and the seven LED bar graph displays the volume level. However, the Selector button can change that.

Push the Selector button once and the first of the three Function LED's illuminate on to indicate that the control knob controls the subwoofer level and the bar graph displays the level of the subwoofer volume.

Push the Selector button twice and the second LED illuminates. The control knob controls the Fader and the bar graph Fader position.

Push the Selector button three times and the third LED comes on to indicate that the control knob controls the level of the input gain and the bar graph indicates the input gain level.

After five seconds the bar graph LED's and the function of the control knob will change back to the default volume level.

Multi-Function Rotary Control

You can control the level of volume, subwoofer, fader and the input gain (line or microphone) by using the rotary control. See *Selector Button and LED's*, above for how to control these functions.

Headphone Jack

This jack is conveniently located for easy access. When you plug your headphones here, it detects and disables all the speakers. When you unplug your headphones, all the speakers are enabled again.

Microphone Jack

This jack is easily accessible and when you plug in a microphone, the Aurilium detects it and disables the Line-In jack in the back. Therefore, if you have a signal going to Line-In, that signal is blocked until you unplug the microphone. You can, however, override the selection, by choosing line in or other available input sources from the Mixer panel of PSA2.

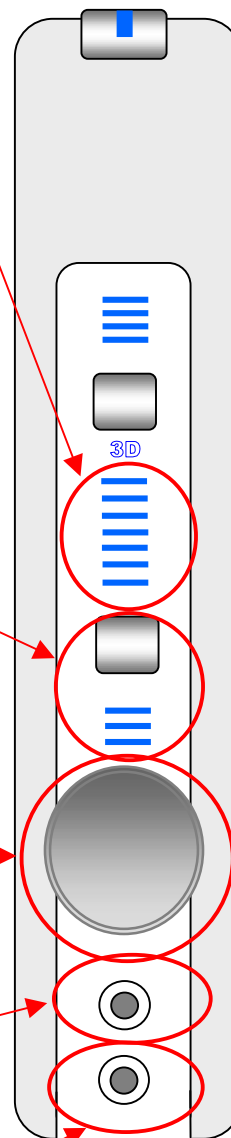

4. The Philips Sound Agent 2 (PSA2)

The Philips Sound Agent 2 is a Graphical User Interface that provides all the unique and powerful features of the Aurilium Sound Processor. The PSA2 and Aurilium have the intelligence to detect the number of speakers connected and the source type of your audio stream. Based on these factors, the system determines the nature of the audio processing and spatial algorithms that deliver the best quality sound possible. However, sound quality is personal and subjective. That is why PSA2 allows the capability to adjust and fine-tune the audio to suit individual taste.

The following sections provide a detail description of the PSA2 features.

4.1. Basic Interface Operation

To launch and setup Philips Sound Agent 2 control panel, double click on the PSA2 icon in the System Tray (normally the lower right hand corner of the screen). **Figure 10.**



Figure 10.

If the PSA2 icon has a red void mark on it, as shown in **Figure 11**, it means the hardware is not connected, or the operating system cannot see the Aurilium.



Figure 11

If the Aurilium is connected to the PC by a USB cable and the red void mark still present, refer to the **Trouble Shooting** section of this document for information on how to eliminate the problem.

When you first launch the PSA2 it appears in the fully expanded form as shown in **Figure 12**. The panel contains three distinct sections, Compact, Main and Visual. You can reduce the expanded form to a compact form using the **Resize** button. The **Compact** control Panel takes up very little space on the screen and it contains the top-level controls. However, to set or change some of the settings, you need to expand to the **Main** control panel. Use the **Resize** button when you need to expand the Main control panel again.

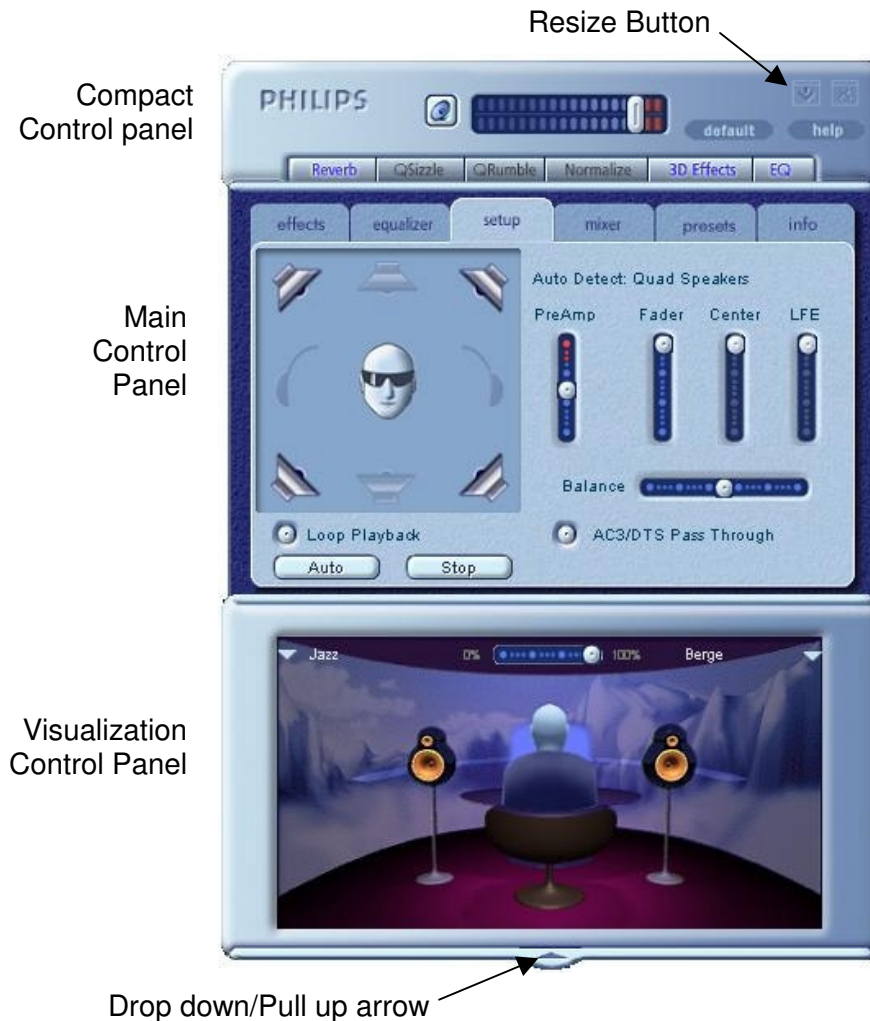

Figure 12.

The Visualization Panel provides a graphic representation of the advanced audio processing features of the Aurilium. It also includes controls to enable the environmental effects. The Visualization Panel appears only in the expanded mode as a sliding cover for the Main Control Panel.

Figure 12 shows four speakers are connected to the Aurilium. The center subwoofer, as well as the headphones are grayed out signifying they are not plugged into the Aurilium.

The following sections contain detailed descriptions of the features of each panel.

4.2. Compact Control Panel

The Compact Control Panel contains the following controls:



Figure 13

Master Volume

Master Volume controls the overall output level of the sound system. This volume control is synchronized with the volume knob on the Aurilium front panel.

Mute

This button toggles the sound on or off to attached speakers or headphones. It is synchronized with the mute button on the Aurilium box.

Resize

Resize Toggles between the compact mode (basic controls) and the expanded mode (for more advanced options).

Close

Closes the PSA2 control panel without affecting audio operation.

Default

Pushing the *Default* button resets most controls to a predefined functional state. All effects except 3D Effects are turned off. All playback mixer sliders except microphone are un-muted. Record sliders remain as set by user. Fader and volume sliders are set to their factory default levels, and Presets are set to Neutral.

Help

This button launches the on-line help system. It contains detail descriptions of all features of the PSA2 interface and its operation.

Reverb

This button toggles the QSound Environmental Modeling (QEM) on or off. However, some games apply their own environmental effects, which are not controlled by this button. Environmental modeling uses reverb (reflected sound) and delay to create the impression that the listener is in a particular environment.

QEM provides a wide range of high-quality environmental modeling effects that are selectable from the Visualization panel. By selecting a default environment, you impose the effects of that environment for music, movies, or games that do not use the EAX feature.

PSA2 responds automatically to games that use the EAX and EAX2.0 commands. These games automatically control the selection of environments (regardless of what is selected from the Visualization panel) to match various scenes and locations, and change these selections as

the environment changes. The applied intensity of reverb is controllable by a slider in the Visualization panel. If the level of Reverb is not as expected, check the slider in the Visualization panel and adjust properly.

QSizzle

Toggles the QSizzle effect. When on, enhances the mid/high frequency range of a digitally compressed audio stream. The button label illuminates when QSizzle is enabled.

QRumble

Toggles the QRumble effect. When on, it enhances the low frequency range of the audio stream. The button label illuminates when QRumble is enabled.

Normalize

Toggles Normalization (automatic volume leveling) on or off. The button label illuminates when Normalization is enabled.

3D Effects

Toggles 3D Effects on or off. This does not affect 3D audio games, but does affect non-3D audio games utilizing the 2D to 3D remixing feature. The button label illuminates when 3D Effects are enabled. To enable automatic audio features such as QSurround, QMSS, and QXpander this feature must be enabled

EQ

Toggles the 10-band Equalizer on and off. The button label lights up when the Equalizer is enabled. When the button is not activated the EQ remains inoperative.

4.3. Main Control Panel

The Main Control Panel is in the center of the expanded mode, and it provides access to advanced settings for most PSA2 controls, which are grouped in five separate tabs. See **Figure 14**.

If only the **Compact** control panel is visible, you must expand it by clicking on the Resize button on the right hand corner, next to the Close icon.

If the Visualization Panel is covering the Main Control Panel, slide the Visualization Panel cover down to reveal the Main Control Panel by clicking on the arrow at the middle of the lower edge of the Visualization Panel.



Figure 14 Effects Tab

Once the Main Control Panel is open, you can choose any of the tabs to select the desired set of controls. The following is a description of each tab from left to right:

4.3.1. Effects Tab

The Effects Tab is the first of the Main Control Panel tabs. Below is a description of all the features on the Effects tab.

QSizzle

QSizzle is a mid and high frequency (treble) enhancement algorithm that helps to compensate for the loss of presence, punch and signal detail that often results from compressed digital media, such as MP3 and WMA formats.

QSizzle self-adjusts in real time according to frequency response of the input signal. This is different from the Equalizer, which is a fixed frequency processor. The Equalizer does not monitor the input signal or perform self-adjustment. The label **QSizzle Active** appears in illuminated text when QSizzle is enabled, and **QSizzle Off** when disabled.

QRumble

QRumble is a powerful low frequency enhancement algorithm that helps to compensate for loss of bass that may result from compressed digital media such as MP3's or WMA formats.

QRumble responds in real time to the varying nature of the input signal, automatically adjusting itself accordingly. This is very different from the Equalizer, which is a static frequency processor. The Equalizer does not monitor the input signal or perform self-adjustment.

The label **QRumble Active** appears in illuminated text when QRumble is enabled, and **QRumble Off** when disabled.

Normalization

Normalization automatically adjusts the volume variations in various audio files or streams. Quieter signals are amplified to match the level of louder ones, so that the listening volume maintains a consistent level. This means that when playing files with various output levels, the need to constantly adjust your speaker volume is minimized.

The label **Normalization Active** appears in illuminated text when Normalization is enabled, and **Normalization Off** when disabled.

3D Effects

Three separate 3D audio enhancement algorithms are provided to maximize the spatial experience no matter what the combination of signal type and output hardware.

When 3D Effects are enabled, the audio processor will automatically choose the appropriate algorithm (3D mode) according to your output configuration and the type of input signal. The 3D Effects indicator LED's on front panel and the indicators on the Effects Tab illuminate to show which algorithm is active at any given time.

QXpander optimizes stereo input played over 2 speakers or headphones. When QXpander is active it provides a wider sound field far exceeding physical position of the speakers.

QSurround optimizes a multi-channel source (e.g. a 5.1 channel DVD) to create "virtual" speakers and immerse the listener in surround sound when using either 5.1, quad or stereo speakers.

QMSS optimizes stereo input sources for playback over a multi-channel speaker set (4 or 5.1 channel). The majority of audio sources are stereo (e.g. MP3's, CD music tracks, WAV files, games, etc). QMSS transforms these stereo sources into immersive multi-channel experience with 4 or 5.1 discrete channels, depending on speaker configuration.

4.3.2. Equalizer Tab

The Equalizer (EQ) controls the frequency response of the system by increasing or decreasing the frequency response of ten independent frequency bands.

This Equalizer works very much the same as the equalizers in high quality sound systems. Each slider controls the relative level of a band (range) of frequencies. The number listed above each slider column is the center frequency of the band controlled by that slider. When a slider is set to the center position, frequencies within this band left flat and the gain is 0dB. See **Figure 15**.



Figure 15

To boost the level of a given band, move its slider above the centerline. To cut the relative level of a given band, move its slider below the centerline. Maximum boost or cut is $\pm 12\text{dB}$ on each frequency level.

Sliders can be individually centered by right clicking anywhere within the slider area, or collectively by clicking the Reset button on top right corner of the panel. Clicking the default button on the compact panel can also collectively center the sliders. Please note that the default button resets several other features as well.

4.3.3. Setup Tab

Located under the setup tab is a speaker configuration panel and other critical audio controls. The speaker configuration panel graphically displays the existing speaker or headphone configuration. Speaker detection is a dynamic and automatic function of PSA2. Simply plug in the speakers or headphones, the PSA2 will detect the configuration and display the new configuration in the panel.

If the configuration is invalid (see invalid configuration description below) a text bubble will pop up at the bottom of the screen. The bubble is displayed until the speaker configuration is corrected or for 30 seconds, whichever occurs first. Also, The speaker status note on the Setup Tab will display “**Invalid Configuration**”.

Note: Not correcting the invalid speaker configuration can result in partial or total loss of the audio.

4.3.3.1. Invalid Speaker Configuration

Connecting the Center/LFE or Rear speakers without connecting the Front speakers is an invalid configuration. Connecting Center/LFE without the Rear speakers is also an invalid configuration even if the Front speakers are connected. There are a total of eight different ways one can connect the speakers, four of which are valid and four are invalid. Connecting the headphones at any time makes an invalid configuration valid and eliminates the warning note.

Valid Configurations	Invalid Configurations
1. No Speakers *	5. Rear only
2. Front only	6. Rear and Center/LFE
3. Front and Rear	7. Center/LFE only
4. Front, Rear, and Center/LFE	8. Front and Center/LFE (no Rear)

* Assuming one uses headphones for output device.



Figure 16

Speaker Test Utility

The Speaker Test Utility can be used to test the current speaker configuration for proper connection to the Aurilium case. Testing each speaker channel ensures each speaker is positioned and connected properly.

The test utility highlights each of the available output channels for testing. Click any active speaker to send the test sound to the corresponding speaker. **Figure 16** shows that headphones are plugged in and the speakers are disabled.

The **Loop Test button** allows the test to repeat until the stop button is pressed. If the Loop Sounds is off, the sound will play once for each click of a speaker button.

The **Test button** sends the test sound to each speaker once and moves to the next speaker automatically. If the Loop Test button and the test button are used in conjunction, the test signal will loop through all attached speakers until the Stop button is pressed.

Speaker Connection Considerations

When connecting speakers it is important that you connect them properly to obtain maximum performance. Connecting to the wrong jack will degrade the quality of the sound output.

If you have only two speakers connect to the **Front** output jack.

If you have four speakers, connect to the **Front** and **Rear** output jacks.

If you have six speakers (5.1), connect to the Front, Rear and Center/LFE output jacks. Ensure that labeling of the speakers match the labeling of the jacks, i.e., front speakers to the front jack, rear speakers to the rear jack and so on.

Preamp Slider

The Preamp Level control allows you to boost the input audio signal before it is processed by the PSA2. It has a similar effect as the master volume, but should not be used instead of it.

NOTE: Increasing the PreAmp may cause audio distortion on some high level input signals. In some cases, an input signal can be of such amplitude that audio distortion can occur at the preamp default level. If this is the case simply lower the preamp level to help eliminate any distortion.

Fader Slider

You can use this slider to control the balance between the front and the rear speakers. You can do the same using the Selector button and the **Multi-Function Rotary Control** on the front panel of the Aurilium.

Center Slider

Center controls the level of output on the center speaker only. Use this slider to adjust the volume on the center speaker.

LFE Slider

This slider allows you to control the volume level of the subwoofer. You can do the same using the Selector button and the **Multi-Function Rotary Control** on the front panel of the Aurilium.

Balance Slider

This slider allows you to balance the left and the right speakers. It affects the front and the rear speakers only.

AC3/DTS Pass Trough

The S/PDIF digital outputs (both optical and RCA) normally supply the digital equivalent of the signal present at the analog (front speakers or headphones) outputs. However, when this button is selected, Dolby Digital (AC3) or DTS audio from DVD playback is passed through to the optical and RCA S/PDIF outputs for external decoding, and all analog outputs are muted including headphones. The Digital Out LED in the front panel of the Aurilium illuminates to indicate this button has been selected. See **Figures 1** and **2**.

NOTE: For proper AC3/DTS pass-thru operation, additional configuration settings may be required by the soft DVD player application used. Refer to the soft DVD player documentation for detailed instructions.

NOTE: When the headphones are connected, the digital output mode is disabled. To enable the digital output mode, disconnect the headphones. Also, when digital output mode is enabled, headphones are muted.

4.3.4. Mixer Tab

Mixer controls allow you to select and control playback and recording input sources.

4.3.4.1. Playback source controls

You can individually mute or un-mute as many playback sources as you wish.

Volume sliders set the playback level for each source.

Balance sliders adjust the relative left and right output levels for each stereo source. Balance sliders should normally be left in the center, which is the default position. Right-click any of the balance sliders to center it.

Depending on the number of available playback sources in your PC, the number of horizontal and vertical slider may vary, and a scrollbar may or may not be preset. The viewing area on the Mixer Tab displays controls for a maximum of four playback sources at one time. Use the Playback Source Scrollbar (if present) to reveal more source controls. See **Figure 17**.

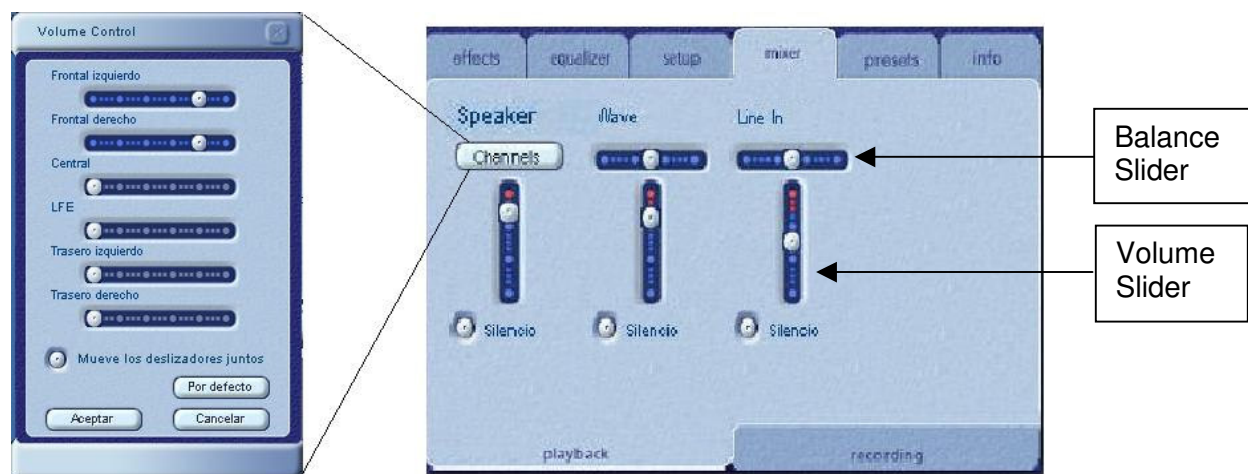

Figure 17

Channel Volume

This button is only available in Windows XP. Use this button if you like to control each speaker individually. Clicking on this button opens up another panel that contains separate control for each speaker, i.e., one can increase or decrease the volume on the right rear speaker. See **Figure 17**. Please NOTE that after adjusting the volume click on the OK button to apply the changes, otherwise, the changes are lost.

When playing audio CD's using the CD ROM driver of the PC, one should enable the digital audio extraction in the system device manager. If you need more information refer to the **Trouble Shooting** section in **Appendix C** of this document.

4.3.4.2. Recording Source Control

The Philips Aurilium allows you to record sounds and music from multiple input sources. Select the “mixer” tab, go to the bottom of the panel and click on the “recording” tab. This panel enables you to select and control recording sources.



Figure 18

Before you start recording, you need to configure the recording source. Select a source by clicking the appropriate “Select” button. Each source has its own level and balance controls. To set each slider in its default position, right click on the sliders.

The default recording source is Line In, but when the Aurilium detects a microphone plugged in, PSA2 automatically makes the microphone the input source for recording. However, the user can override this selection and assign a different source through the Recording panel of PSA2.

Monitor Line In

The function of the Monitor button is to allow the user to hear the audio that is being recorded. When the Monitor button is pressed, it selects the input signal and sends it to the Front Speakers. This means the front speakers will not output the audio that is streamed by any audio application or by the system as long as the monitor button is pressed. The button is only active if line-in is selected as the capture device. If any other source is selected, monitor is turned off and the button is disabled.

The Aurilium provides extra amplification for weaker microphone signals. You can increase or decrease the Input Gain using the Rotary Control knob, but first you have to select “Input Gain” using the Selector button, right above the volume knob on the front panel of the Aurilium. The “Input Gain” LED will light up and the 7-segment bar graph LEDs will reflect the level you have selected. If distortion occurs, lower the gain level.

4.3.5. Presets Tab

The Preset functions enable you to make snapshots of the state of all Philips Sound Agent 2 controls, so that you can conveniently reload the same settings at any time.



Figure 19

The Preset system enables you to save the state of PSA2 controls once you have made adjustments to customize your listening experience, so you can recall settings for any source and playback environment.

For example, if you have been listening to music with predominant drums and bass and have adjusted the controls to suit your taste, you can quickly save a preset called “Drums’n’Bass”. Whenever you listen to this type of music again, simply load this preset, and all the controls will return to the settings you had in effect when you saved it.

Sound Agent 2 comes with six factory presets as listed on the Presets tab. The following is a description of each feature on the Presets tab.

Load

Clicking on this button loads an existing preset. To load another preset, highlight it on the list and click the **Load**.

Save

When you load one of your presets and make changes to it, you can save it by clicking on the **Save** button. If you have selected one of the factory presets and made changes to it, you will have to save it under a different name. Sound Agent 2 will not overwrite factory presets, but you can overwrite your own unique presets.

Save As

You can load an existing preset (factory or one of yours), modify it to your taste, and save it as a new preset.

Delete

Deletes the selected preset permanently from the list. When you select one your presets and click on this button, a confirmation dialog box will appear and when you confirm by clicking the OK button, the preset will be removed from the list. This button will not delete any of the factory presets.

4.3.6. Info Tab

This tab contains useful information regarding the product. It includes the software driver's version number, manufacturer's name, and web page addresses.

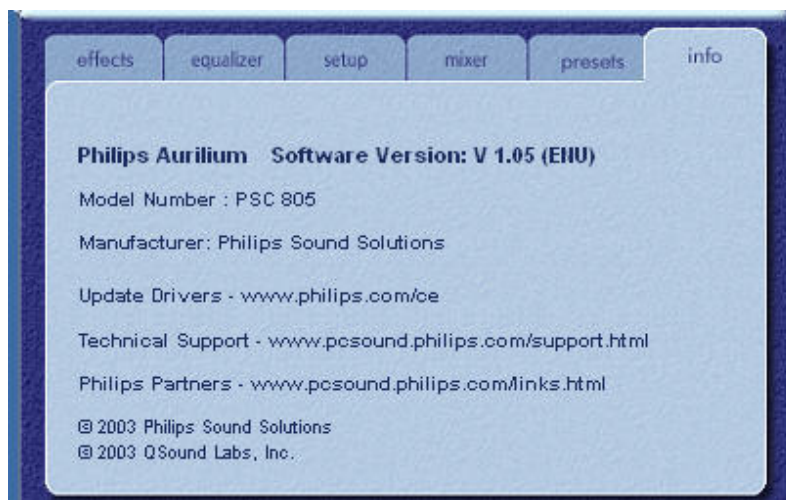

Figure 20

4.4. Visualization Panel

The Visualization Panel provides a graphical representation of the environments and effects that are created by Sound Agent 2. It also contains two drop-down menus and the Reverb Intensity Slider.

The drop-down menu on the right contains fifteen different reverb environmental effects to select. To select a reverb environment, the Reverb button located on the Compact Control Panel must be enabled.

The drop-down menu on the left contains all factory and user defined presets for various types of music. This menu allows easy preset access via the Visualization Control Panel.

The top center horizontal slider controls the intensity of the reverb effect that is being applied. Adjust as necessary to achieve the right amount of Reverb based on individual content.

The Visualization Panel may be moved up and down to conceal or reveal the Main Control Panel by clicking the arrow at the bottom center of the panel.



Figure 21

5. Uninstalling PSA2

If for any reason it becomes necessary to uninstall the PSA2 drivers, you can choose one of two available methods. You may go to the system control panel and launch the “Add/Remove Programs” utility as shown in **Figure 22** and **Figure 23**. From the list of programs find PSC805 and click on it so it is highlighted. Click the “Change/Remove” button.

Or, you may choose the uninstall program that comes with PSA2 program. For this you click on the Windows Start button, click on the “Programs”, (“All Programs” in XP), click on the Philips folder, then select and execute the Philips Uninstall program.

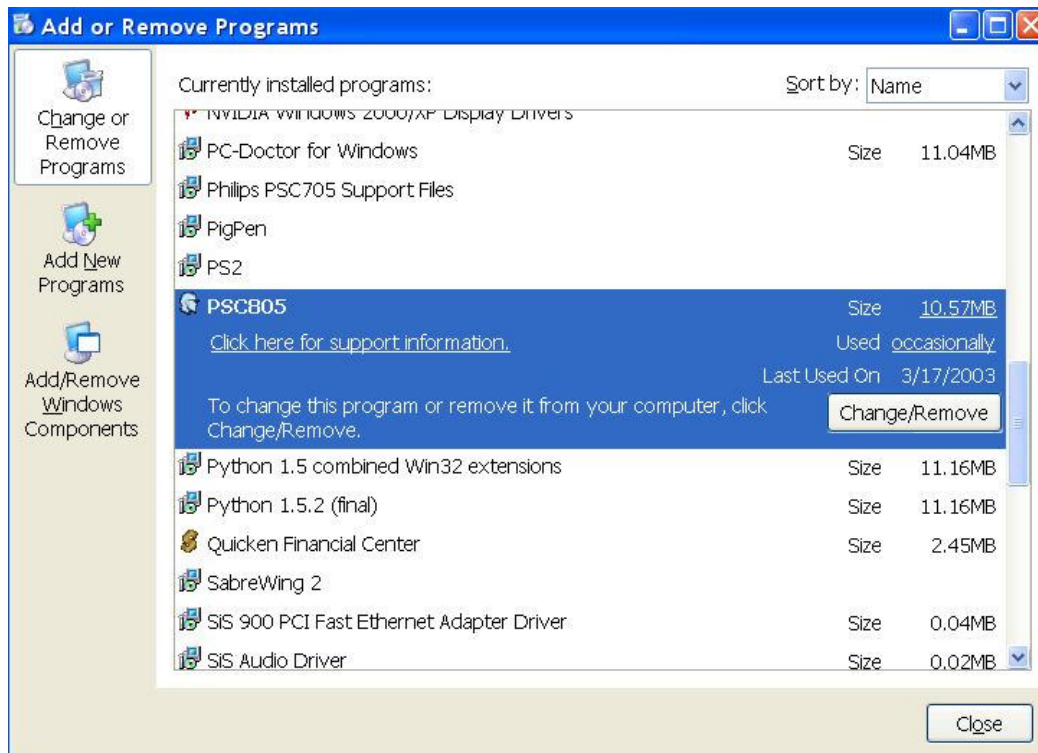

Figure 22 Windows XP

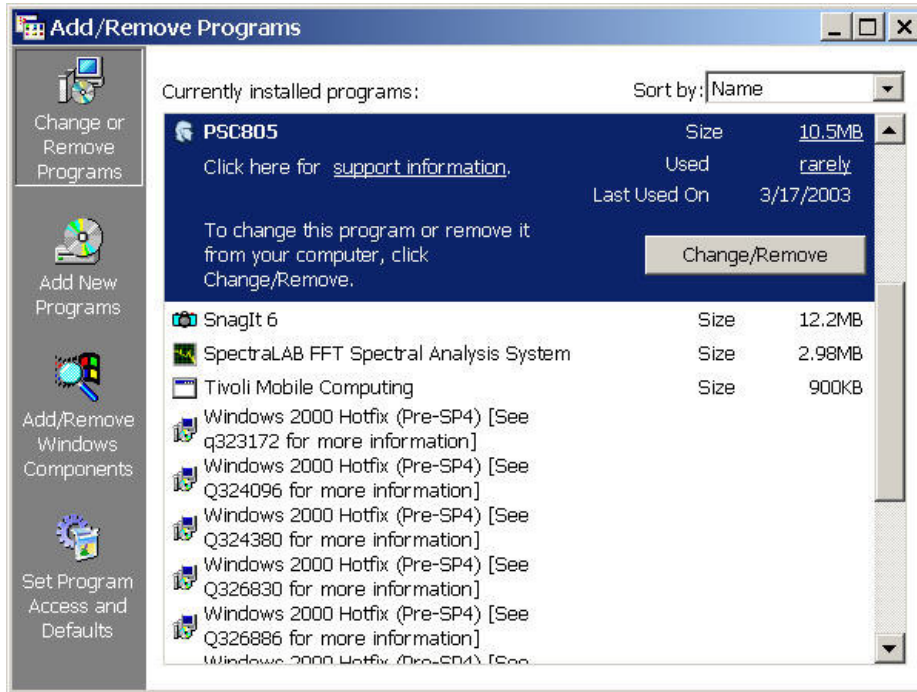

Figure 23 Windows 2000

6. Technical Support And Warranty

Before calling the technical support number please make sure you have the following information available:

- Model number and date of purchase.
- Computer type, processor speed, and memory available.
- Computer operating system (IE; Windows® 2000, or XP).
- On-screen error information.
- Other hardware connected to the Aurilium.

6.1. Internet Address:

Useful information such as the latest drivers and products can be found at:

www.pcsound.philips.com

The web site for Europe is:

<http://www.philips.com/sound>

Philips general web site is:

<http://www.philips.com/ce>

6.2. Technical Support Information:

Toll-Free telephone numbers:

Available 6:00 AM – 10:00 PM Central Standard Time

USA: 1-800-835-3506

Elsewhere: See the Warranty Conditions document in your package.

7. Appendix A, Useful Tips For Speaker setup

Following is some suggestions to help you set up your speakers for best results.

7.1.1. Ideal Listening Scenario (Speakers)

The ideal way to experience proper imaging, whether stereo, surround, or 3D, is to begin by arranging each pair of speakers as symmetrically as possible.

Front speakers should be at the same height, angle and distance relative to the listener. You will obtain best imaging if the distance between you and speakers are about the same distance as between the speakers.

A typical multimedia set-up, with the speakers placed just to either side of the computer monitor, is ideal for stereo or quad listening. However, if your system has a center speaker, then it is advisable to move the left and right front speakers further apart, maintaining equal distance from the listening position.

Surround speakers should be placed behind the listener, and ideally be no further than the front speakers from the listener. They also need to be at the same height and angle as the front speakers.

7.1.2. Ideal Listening Scenario (Headphones)

When using headphones, many of the potential problems associated with speaker listening are essentially eliminated. For example, you are automatically positioned in the center, and if you move around, this doesn't change your position relative to the speakers.

7.1.3. Avoid Reflective Surfaces (Speakers)

If possible, keep your speakers away from reflective surfaces. For example, if your setup is in a corner and one speaker is very close to a sidewall, this will degrade imaging. This is because sound waves will bounce off the wall and arrive at your ears slightly later than the waves originating directly from the speaker.

This is true of any environment except an anechoic (echo-free) chamber. However, when the surface is close to the speaker, the reflected sound energy will be only slightly delayed and still quite strong compared to the original, which will reduce the clarity of the signal you hear.

The same can be true of placing your speakers directly on a hard desktop. If possible, elevate your speakers on stands so they are further away from the reflective surface. This will slightly improve the imaging and effects.

7.1.4. Balance the Speakers and Headphones

Any imaging, including stereo, surround and especially 3D audio, can be degraded by left/right channel imbalances. If your speakers or amplifier(s) incorporate balance controls, we strongly recommend adjusting them to their center position. Many physical balance controls have a mark to identify the center position.

If each speaker has separate volume controls, try to set them as equally as possible. You can use the Philips Sound Agent 2 test utility to help you judge the volume levels.

This practice applies to headphones as well.

8. Appendix B, USB Hub Considerations

8.1. Introduction to USB Hub

A hub is a USB device that uses one USB port for connection to a PC and typically provides four additional ports for connection to USB devices. The function is similar to an electrical plug expander or an extension cord with multiple receptacles.

Some of the earlier computers have only two USB ports that are usually located on the back-side of the computer. In this case if we have more than two USB devices for connection to the PC we need to use a USB hub. Using a hub not only provides more USB ports, but also provides easy access to the ports that are located in the back of the computer.

Most newer computers have two USB ports in the back and two additional ports in the front. The front ports are usually concealed under a flip up or flip down cover. Refer to your PC document to locate these ports.

A USB host controller card may be added to a computer if it does not have any USB ports at all. These cards need to be installed inside the computer in a PCI slot.

8.1.1. Power Limitation

Hubs, like any USB device, may be bus-powered or self-powered. A self-powered hub has an external power supply, which plugs into an electrical outlet, and can provide maximum specified power to all its USB ports. A bus-powered hub draws power from the root USB port, and thus, it has limited power available to the connecting USB devices.

8.1.2. Bandwidth Limitation Issues

Each USB port on the PC has a maximum bandwidth of 12 Mega-bits per second (Mbps). Different USB devices require different amount of bandwidth. Connecting more than two high bandwidth-demanding devices to a hub may cause degradation of functionality for some or all of the devices on that hub. For example, connecting a web camera and an audio device to the same hub may cause gaps in the displayed video, or gaps in the audio stream. It may even cause the devices not to function at all. This usually happens to the device that is used last when other USB devices are active.

9. Appendix C, Trouble Shooting

This appendix covers some of the basic mistakes and pitfalls you might encounter.

No Sound is coming out

1. Check the speakers.
 - a. Ensure the speakers are plugged into the back of the Aurilium.
 - b. Ensure the speaker power supply plugged into the AC power outlet, or if they use batteries, try new batteries.
 - c. Ensure the speaker volume turned up.
2. Check the mute button to ensure it is deactivated, i.e., the LED on the Aurilium mute button is off.
3. Check the Aurilium volume knob and turn it up.
4. Click on default button on the PSA2 compact panel.

System Error Message

When attempting to launch an audio player application, on a rare occasion you may see one of the following error messages depending on the operating system of the PC. This error message also causes no audio to be played.



Windows XP



Windows 2000

Figure 24

This error message is generated due to lack of sufficient bandwidth on the USB hub that the Aurilium is plugged into. If you have a USB imaging device (such as a webcam or a scanner) and you have an imaging application open, and try to open an audio player application such as Winamp or Windows Media Player.

Solution

Click “Close” or “No” depending of which error message you have.

Close the audio player application.

Close the imaging application.

Reopen the audio player application and play the audio stream.

Hardware Not Installed

If the operating system fails to recognize the Aurilium as a USB device and does not inform you of proper hardware installation, you may see the PSA2 icon marked with a red void sign in the Windows System Tray as shown in **Figure 25**:

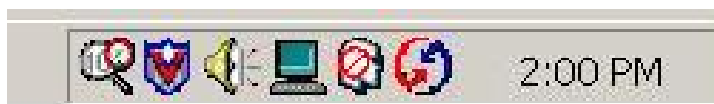

Figure 25

Solution

Unplug the USB cable of the Aurilium, wait two or three seconds and plug it back in to the SUB port. It usually takes several seconds or longer for the operating system to recognize and register the USB audio device. The red void mark should go away as soon as the hardware is registered.

To check whether the operating system has registered the USB audio hardware, use the following steps. There are three instances of the PSC805 in the device manager.

Windows 2000

- Right click on **My Computer** icon
- Scroll down and click on **Properties**
- Click on **Hardware** tab
- Click on **Device Manager** button
- Click on the + sign next to the **Human Interface Devices**. This might not be present if the Aurilium is not registered, and there are no HID's attached to the PC. If the OS has recognized the Aurilium, one or two HID items should be listed here.
- Click on the + sign next to **Sound, video and game controllers**. “USB Audio device” should be one of the items in the list.
- Click on the + sign next to **“Universal Serial Bus controllers”**. “USB Composite Device” should be one of the items in the list.

- If none of the above exists, it means the Aurilium is not recognized by the OS and you need to unplug and plug the Aurilium again. Every time you plug the Aurilium, you should monitor the PSA2 icon in the System Tray to make sure the red void mark has disappeared before using the sound system.
- If only one or two of the above exist but not all three, the enumeration process has not completed. In this case unplug the Aurilium, close all applications and shut down the system from the start menu. Wait for at least 10 seconds and restart the computer. Plug in the Aurilium and monitor PSA2 icon. There should not be a red void mark on the icon.

Windows XP

To launch the device manager from Windows XP check the desktop for My Computer icon first. If it is on the desktop follow all the steps listed for Windows 2000. If the icon is not on desktop, go to the Start menu find My Computer icon (normally on top of the right hand column) and right click on it. Follow all the steps listed above for Windows 2000.



No Audio When Playing Audio CD in the CD Drive

The system CD ROM drive could be used to play audio CD's. However, it must be configured to extract the audio digitally and send it over the system data lines to the Aurilium to be played. Here are the steps to enable this feature:

Windows 2000

1. Right click on "My Computer". On Windows 2000 this icon on desktop. On Windows XP it is in the upper right portion of the Start menu.
2. Scroll down to "Properties" and click on it.
3. Click on "Hardware" tab.
4. Click on "Device Manager" button at the middle of panel.
5. Click on the + sign next to the DVD/CD-ROM Drives.
6. Right click on the CD ROM drive that appears. If there are more than one CD ROM drives, click on the one that is being used for audio CD playing.
7. Scroll down to "Properties" and click on it.
8. A new panel opens. See Figure 26
9. Click on the Properties tab
10. Click to select the box with the label "Enable digital CD for this CD-ROM device"
11. Click the OK button and close all the relating windows.

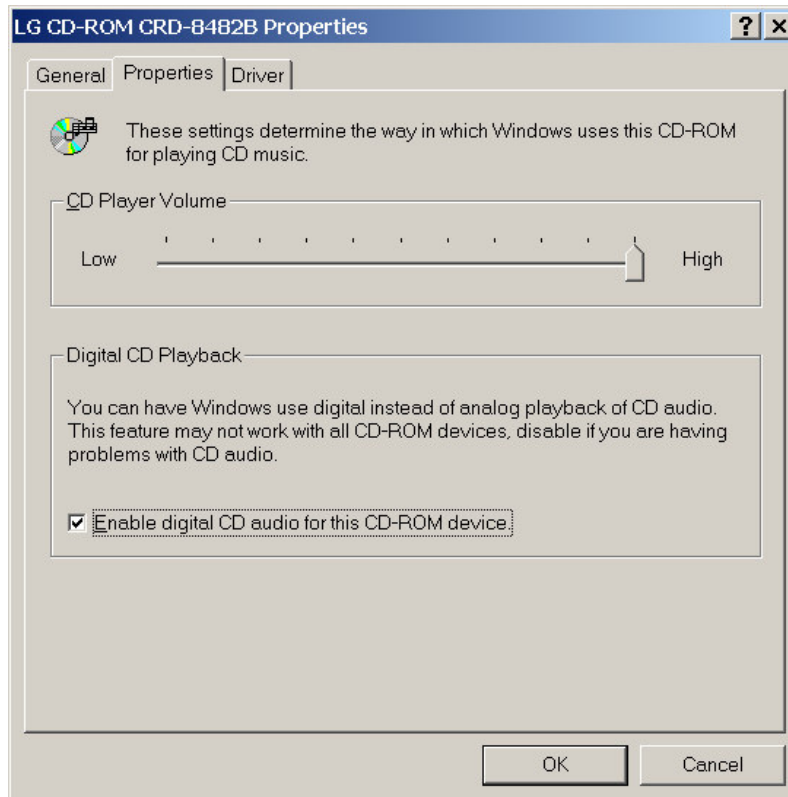

Figure 26

🔊 CD Player Control in the mixer playback tab dose not have any effects on the output when Playing Audio CD in the CD Drive

Because the CD player sends the audio streams via the digital data lines, Windows treats this source like other digital audio sources such as MP3 files. Therefore, to control the volume and balance use the controls for “wave”.

🔊 No PSA2 Icon in the System Tray

After you have installed PSA2 from the installation CD, if the PSA2 icon disappears from the System Tray, go to the start menu, click on Programs (Windows 2000 or Windows XP), click on Philips, then click on Philips PSC805, then click on PSC805 PSA2 Control Panel.

🔊 When playing DVD there is background music but no dialog, or the dialog is very low

Check speaker connection. This may happen if the front speakers are not connected while the rear and subwoofer are. If the speakers are connected correctly and this happens it is possible that the sound track of the DVD is corrupted or damaged. One may test the sound track by connecting a set of headphones to the Aurilium and listen to the sound. The headphones always output the down-mixed sound track. If the headphones sound similar to the speakers, then the sound track is corrupted.

🔊 Error message appears on the screen

The error message in **Figure 27** is displayed when the speaker configuration is not correct. Check to ensure that front speakers are connected to the right connector in the back of the Aurilium.



Figure 27

The speaker connectors are color coded for clarity. Lime Green is for Front speakers. Black is for Rear, and orange is for Center/ LFE or subwoofer. See **Figure 2**. For more information also refer to the **Setup Tab** section of this document.

The correct configuration is as follows:

No. of Speakers	Where to Connect
Two Speakers	Connect to the FRONT connector in back of the Aurilium.
Four Speakers	Connect to FRONT and REAR connectors.
Five or six Speakers	Connect to FRONT, REAR and Center/LFE connectors.
Headphones	Connect to the headphone jack on the front panel of the Aurilium.